

6

5

4

3

2

1

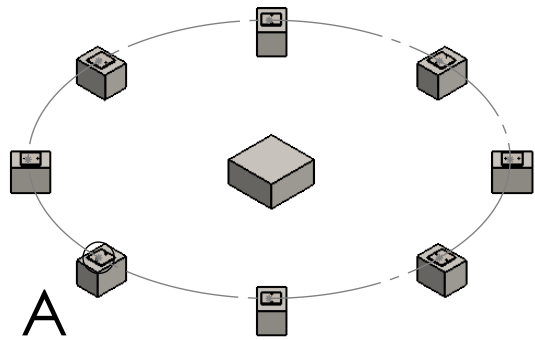

A

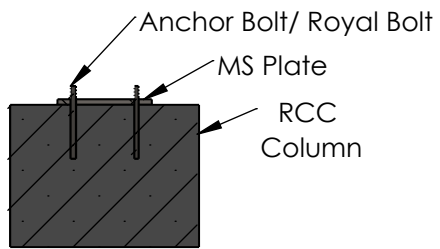

**Cross section
of column**

REMARK:

- (1) Anchor bolt/Royal Bolt: 1/2"-8EA 16 Pcs
- (2) Every foundation Should maintain equal horizontal line.
- (3) Load is distributed over the foundation equally.
- (4) Recommended foundation height is 300 mm.
- (5) For each case anchor bolts should extrude about 40mm from concrete.

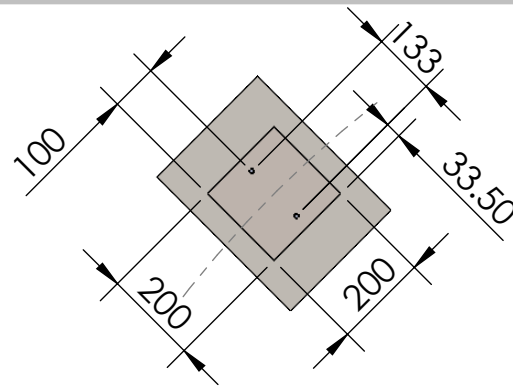

DETAIL E
SCALE 1 : 16

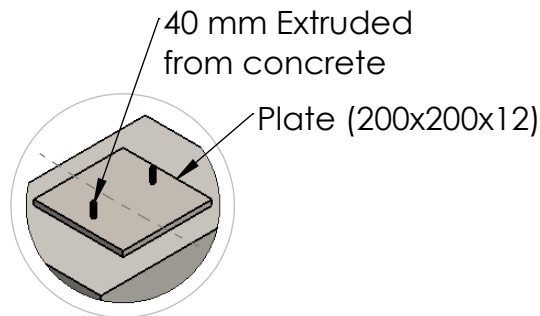

**Magnified View
of Plate**

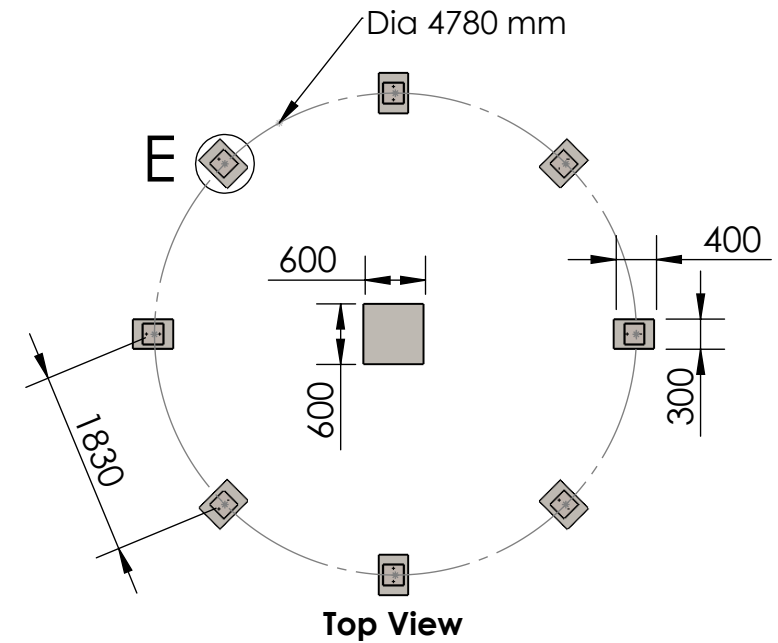

Top View

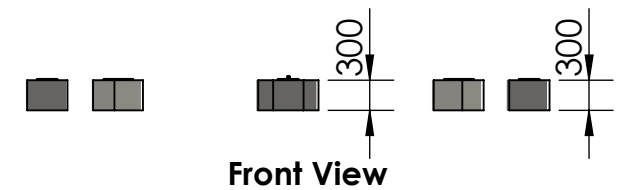

Front View

UNLESS OTHERWISE SPECIFIED: DIMENSIONS ARE IN MILLIMETERS SURFACE FINISH: TOLERANCES: LINEAR: ANGULAR:				FINISH:		DEBURR AND BREAK SHARP EDGES		DO NOT SCALE DRAWING		REVISION	
TITLE: Foundation Drawing (ART-400)											
DRAWN: Mahmuda								DATE: 31/1/18		 <p>Artisan Craft (Bd) Ltd. We come when Temperature matters www.artisan-craft.com</p>	
CHK'D: Shahed								DATE: 31/1/18			
APPV'D: Shahed								DATE: 31/1/18			
MFG: N/A											
Q.A: N/A											
MATERIAL: RCC								DWG NO. DR-C-F-011		A4	
WEIGHT:								SCALE:1:75		SHEET 1 OF 1	

6

5

4

3

2

1

D

C

B

A